



The Maxiva™ UAX air-cooled UHF solid-state transmitter incorporates Harris® PowerSmart® and Apex M2X™ multimedia exciter technologies to provide today's broadcaster unmatched performance, reliability and quality. Designed with future broadcasting needs in mind, the Maxiva UAX transmitter is a single transmitter platform capable of DVB-T/H, DVB-T2, ATSC, ATSC Mobile DTV, ISDB-Tb, CMMB, CTTB, FLO™ or other digital standards.

For pre-filter power output requirements up to 2.5 kW COFDM, 2.5kW 8VSB, and 3.75 kW analog, the Maxiva UAX transmitter is capable of serving broadcasters needs for efficient, easy to maintain transmitter systems. The UAX utilizes the Harris platform technologies such as the Apex M2X multimedia exciter, PowerSmart technology and 50v LDMOS amplifier devices. This powerful blend provides best-in-class performance with respect to transmitter RF performance, efficiency, size, and upgradeability.

### PRODUCT DETAILS

#### Increased Density and Efficiency via Harris PowerSmart Technology

Featuring Harris PowerSmart technology in its transmitter architecture, the Maxiva UAX line offers superior power and efficiency. New 50-volt LDMOS device technology delivers a dramatic increase in power density, lower operating costs and reduced cost of ownership over the life of the transmitter.

#### Improved Uptime and Reduced Service Costs

Redundant PA and universal power supply (PS) modules simplify on-air servicing and eliminate costly interruptions. Lightweight pallets and modules facilitate overnight/same-day shipping for simple, cost-effective spares holding. The Maxiva UAX transmitter also supports replacement of pre-tuned amplifier pallets in the field, eliminating the need for complex tuning after FET replacement.

#### Maximized Coverage with the Apex M2X Exciter

Utilizing the Harris Apex M2X multimedia exciter, the Maxiva UAX transmitter takes digital and mobile TV to the next level. Harris digital exciters have logged more hours in real-time broadcast than all others combined. The Apex M2X exciter provides a flawless signal with complete technical and regulatory compliance for tube- and solid-state digital transmitters.

Apex M2X supports a wide range of global digital standards including ATSC, ATSC Mobile DTV, DVB-T/H, ISDB-TB, FLO, CTTB, CMMB and a range of analog TV standards, including NTSC and PAL. It allows for a smooth conversion to digital transmission, and this flexibility, coupled with the exclusive Real-Time Adaptive Correction (RTAC) technology incorporated in the exciter, provides superior performance.

### FEATURES

- PowerSmart technology, for best-in-class power efficiency and lowest operating costs
- Rugged, reliable design and construction
- Digital and analog power levels up to 2.5 kW and 3.75 kW, respectively (before filter)
- Apex M2X exciter technology, allowing easy migration from analog to digital or between different standards
- Real-Time Adaptive Correction (RTAC™) technology is included with every system
- Fully broadband power amplifier (PA) modules — 470 to 862 MHz
- 1:1 PA module to power supply (PS) redundancy
- Hot-pluggable air-cooled linear RF amplifier modules and power supplies for simplified maintenance
- Optional Transmitter Control Unit for straightforward control, monitoring and diagnostics
- Web-enabled remote graphical user interface (GUI)

#### Compact Footprint

Suited for crowded, shared transmitter sites, the Maxiva UAX transmitter reduces facility space requirements and simplifies installation.

#### Powerful, Straightforward Monitoring and Control

The main system control is located in the low-power unit and communicates with each amplifier bay that has independent protection and control capabilities. Each power amplifier (PA) module has dedicated control and monitoring to support on/off functionality and alarms for reflected power, temperature and current overloads.

For maximum functionality, all dual drive Maxiva UAX systems include a Transmitter Control Unit (TCU). The TCU includes two parallel levels of operational support: a main microprocessor based controller and a back-up, or "life-support" controller. The main controller provides a front-panel, color touch-screen display, SNMP communications support and IP connectivity via the built-in Web GUI. Ideal for network operations, the control system can be accessed from anywhere in the world via TCP/IP over a telecom or network connection. The back-up controller provides minimal control and monitoring of the transmitter platform, using a small number of parallel signals, simple interface controls and front-panel controls and indicators.

# Maxiva™ UAX

## Air-Cooled UHF Multimedia TV Transmitter

### SPECIFICATIONS

Specifications are subject to change without notice.

#### General

Frequency Range	470 to 862 MHz
Channel Bandwidth	6, 7 or 8 MHz
RF Load Impedance	50 ohms, 1.1:1 VSWR over any single TV channel
RF Output Connector	Type-N female, 7-16 DIN or 1-5/8 in. EIA connector size dependent upon power level

#### AC Mains

AC Mains Requirement	UAX-10/15, UAX-50/75, UAV 100/150: Single-phase 110 to 127 V, 50/60 Hz, 10/-15%, or single-phase 208 to 240 V, 50/60 Hz, 10/-15% UAX-250/375, UAX-500/750, UAX-1000/1500, UAX-2000/3000: Single-phase 208 to 240 V, 50/60 Hz, 10/-15%, or three-phase 208 to 240 V, 50/60 Hz, Wye or Delta, 10/-15%, or three-phase 380 to 415 V, 50/60 Hz, Wye only, 10/-15%.
----------------------	--

Power Factor . . . . . >0.90

#### Environmental

Altitude	Up to 13,123 ft (4,000 m) elevation above mean sea level
Ambient Temperature Range	32° to 113° F (0° to 45° C) at sea level (upper limit derated 3.6° F (2° C) per 1000 ft (305 m) elevation AMSL)
Humidity	95%, non-condensing
Cooling Method	Air input with built-in filter at front; air exhaust with built-in DC fans at rear; ducted air exhaust and/or input available as option

#### Analog

Analog Television Systems	CCIR G, I, K, K1, M, N
Color Systems	PAL, NTSC, SECAM
Sound Systems	Monaural, BTSC, IRT, NICAM G
Power Output (vision peak of sync)	15 W to 3 kW available (after filter)

#### Analog Video Performance

Video Input	2 inputs 75 ohms, 0.7 to 1.4 V, 75 ohms, 34 dB return loss
Regulation of Output Power <sup>1</sup>	±3%
Variation of Output Power <sup>2</sup>	±2%
Vision Sideband Response <sup>3</sup>	PAL system G shown (other systems available)
-1.25 MHz and below	-20 dB or less
-4.43 MHz	-30 dB or less
-0.75 to -1.25 MHz	+0.5 dB or less
-0.5 to +4.5 MHz	+0.5 to -0.5 dB
+5.0 MHz	+0.5 to -2.5 dB
+5.75 MHz and above	-35 dB or less
Frequency Stability <sup>4</sup>	±150 Hz/month
Differential Gain <sup>5</sup>	3%
Differential Phase <sup>5</sup>	3°
Low Frequency Linearity <sup>6</sup>	10%
Incidental Carrier Phase	
Modulation <sup>5</sup>	±2°
Signal to Noise Ratio	>60 dB (weighted)
K Factor	2% or less with 2T sin <sup>2</sup> pulse
20T Equivalent Gain and Delay	3% total baseline distortion

Spurious and Harmonic Radiation	-60 dB or better
In-Channel Intermodulation	
Distortion	-58 dB (-60 dB typical)

#### Analog Sound Performance

Frequency Stability <sup>4</sup>	±150 Hz/month
Modulation Capability	±120 kHz peak deviation
Monaural Input	Adjustable 0 to +12 dBm, 600 ohms, balanced, >30 dB return loss
Pre-Emphasis	Selectable 75 or 50 µs
Frequency Response	±0.5 dB, 40 Hz to 15 kHz
Harmonic Distortion	0.5%, 30 Hz to 15 kHz
FM Noise	60 dB RMS with de-emphasis
AM Noise	50 dB RMS from 30 Hz to 15 kHz
Synchronous AM Noise	40 dB RMS at 400 Hz with ±25 kHz deviation
IRT Sound	Available upon request
NICAM Sound	Available upon request

#### DVB-T, DVB-T2, ISDB-TB, CMMB, FLO, CTTB

Power Output (average)	13 W to 2.5 kW available; measured before optional mask filter
Systems	DVB-T, standard ETS 300744, ISDB-TB (Brazil standard)
ASI Inputs	4 BNC type, female; 75 ohms acc. to EN 50083-9 (2 main/2 hierarchical)
Output Power Reduction	0 dB to -6 dB
Crest Factor	Maximum 13 dB
Shoulder Level	<-37 dB (before mask filter)
END	≤0.7 dB
MER	>34 dB
Harmonics (before filter)	<-40 dB
Central Carrier Suppression	>75 dB
Frequency Stability (without external reference)	±150 Hz/month
Frequency Offsets	1 Hz resolution

#### ATSC

Power Output (average)	13 W to 2.5 kW available; measured before optional mask filter
System	ATSC A/153, 8-VSB DTV standard
Data Input	19.39 Mb/s
Impedance	75 ohms, unbalanced
Standard	SMPTE 310M
Connector	2 BNC, female, isolated
External Precise Frequency Input	10 MHz, sinusoidal
Impedance	50 ohms, unbalanced
Level	0 to +10 dBm
Connector	BNC 50 ohms, female
Signal to Noise (EVM)	27 dB or better (4% or less)
Phase Noise	<104 dBc/Hz @ 20 kHz offset (ATSC A/64)
Pilot Frequency Stability	Less than ±150 Hz/month Less than ±3 Hz with internal or external PFC
Harmonic Radiation and Spurious	Meets mask requirements specified in FCC 5th and 6th report and order
Sideband Performance	Compliant with FCC radiation mask, when measured at the output of Harris-supplied output filter

# Maxiva™ UAX

## Air-Cooled UHF Multimedia TV Transmitter

TELEVISION TRANSMISSION // UHF TRANSMITTERS

### Remote Control

Parallel Remote . . . . . DB-37, female  
 Relay Contacts . . . . . 25 mA @ 24 VDC  
 Digital Inputs (TTL level) . . . . . Pulse duration ≥100 ms or permanent signal  
 Ethernet/SNMP (optional) . . . . . RJ-45, twisted pair

### Compliance

- RoHS: 2002/95/EC
- R&TTE: 1999/5/EC
- Safety: EN 60215
- EMC: EN 301-489-1
- FCC Part 73

- <sup>1</sup> Variation of peak output power with a change in average picture level from black to white (0% to 100%).
- <sup>2</sup> Peak-to-peak variation of peak sync voltage during one field using field test signal per EIA-508.
- <sup>3</sup> Response specified for transmitter operating into a resistive load of 1.05:1 VSWR.
- <sup>4</sup> After initial aging of 60 days.
- <sup>5</sup> Measured using 20% peak-to-peak amplitude swept video modulation with pedestal set at 10%, 50% and 90% APL. All percentages relative to a blanking to white transition.
- <sup>6</sup> Measured using a 5-step staircase signal. Test signal #3, CCIR REC. #421-3 Derate maximum temperature by 3.6° F (2° C) per 1,000 ft (305 m) above mean sea level.

Digital Models (xx = modulation)	Power Before Filter (Watts)	Power After Filter (Watts)	RF Output Connector	Total Rack Space (*with dual exciters)
UAX-10xx	13	10	"N" Female	4RU
UAX-50xx	63	50	"N" Female	4RU
UAX-100xx	125	100	"N" Female	4RU
UAX-250xx	313	250	7-16 DIN	9RU
UAX-500xx	625	500	7-16 DIN	9RU
UAX-1000xx	1,250	1,000	7-16 DIN	14RU*/21RU
UAX-2000xx	2,500	2,000	1-5/8" EIA	24RU*/31RU

Analog Models	Power Before Filter (Watts)	Power After Filter (Watts)	RF Output Connector	Total Rack Space (*with dual exciters)
UAX-15AN	19	15	"N" Female	4RU
UAX-75AN	94	75	"N" Female	4RU
UAX-150AN	188	150	"N" Female	4RU
UAX-375AN	313	375	7-16 DIN	9RU
UAX-750AN	938	750	7-16 DIN	9RU
UAX-1500AN	1,875	1,500	7-16 DIN	14RU*/21RU
UAX-3000AN	3,750	3,000	1-5/8" EIA	24RU*/31RU

### Digital Modulations AT: ATSC:

DV: DVB-T/H  
 T2: DVB-T2  
 IS: ISDB-Tb  
 CM: CMMB  
 CT: CTTB  
 FL: FLOTV

# Maxiva™ UAX

Air-Cooled UHF Multimedia TV Transmitter

TELEVISION TRANSMISSION // UHF TRANSMITTERS

## IMAGES/DIAGRAMS

UAX-10 Digital/UAX-15AN

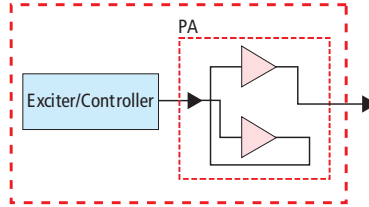

UAX-50/100 Digital/UAX-75/150AN

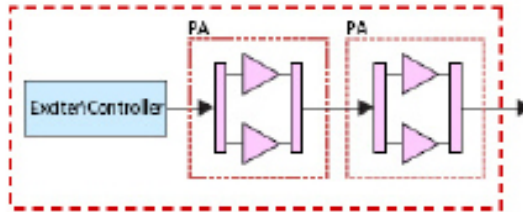

UAX-250 Digital/UAX-375AN

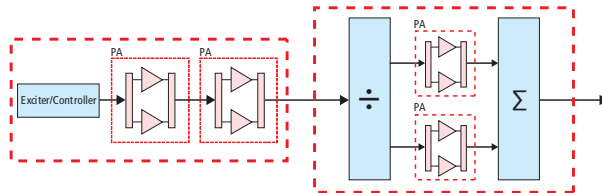

UAX-500 Digital/UAX-750AN

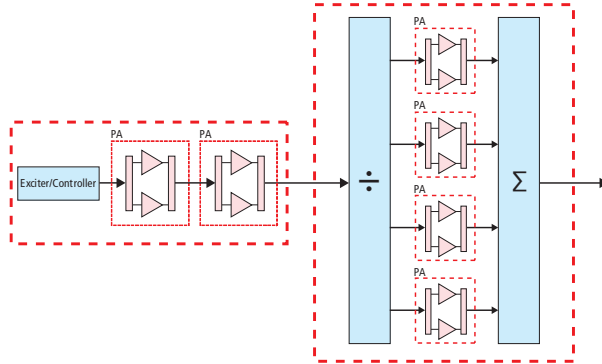

# Maxiva™ UAX

Air-Cooled UHF Multimedia TV Transmitter

TELEVISION TRANSMISSION // UHF TRANSMITTERS

UAX-1000 Digital/UAX-1500AN

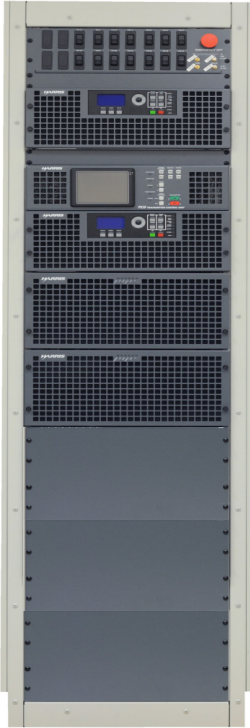

(Shown with 44RU deluxe rack)

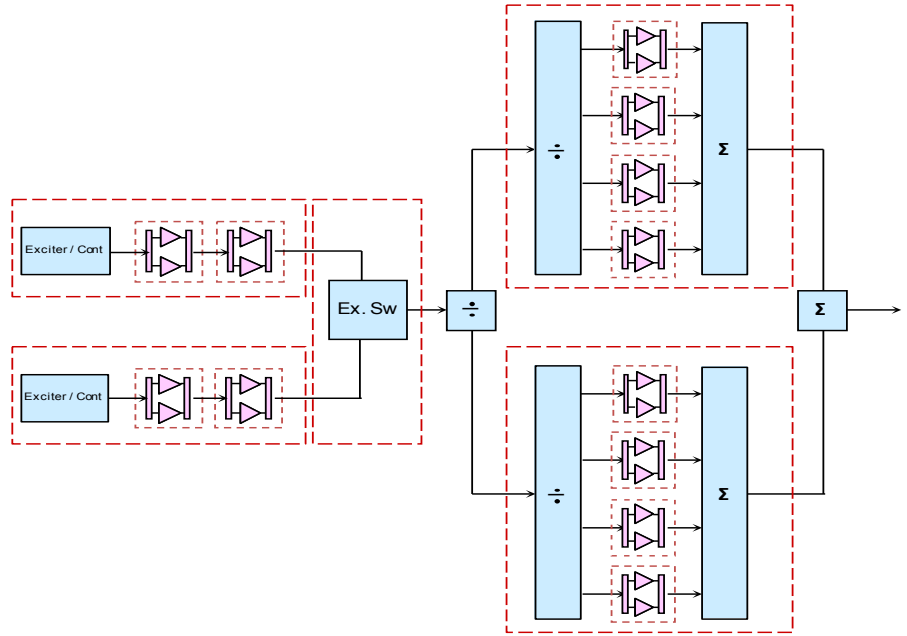

UAX-2000 Digital/UAX-3000AN

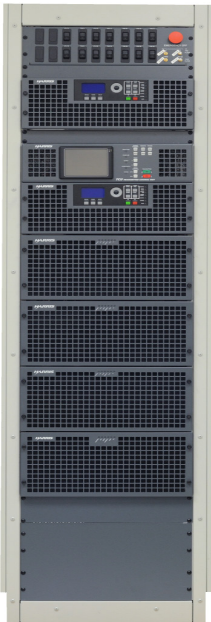

(With optional dual exciters in 44 RU deluxe rack)

